



A T C S C M 2 0 A S L P r o / S C M 2 0 P S L P r o
U s e r O p e r a t i n g M a n u a l



Safety Warnings

1. Read instructions – all the safety and operating instructions should be read before the appliance is operated.
2. Retain these instructions – the safety and operating instructions should be retained for future reference.
3. Heed warnings – all warnings on the appliance and in the operating instructions should be adhered to.
4. Follow instructions – all operating and other instructions should be followed.
5. Water and moisture - the appliance should not be exposed to dripping or splashing and no objects such as vases, should be placed on the appliance.
6. Ventilation - a minimum of 80mm is required at the rear of the appliance to ensure sufficient ventilation. The ventilation should not be impeded by covering the appliance with items such as table-cloths, curtains etc. Further, the appliance should not be built into an installation, such as a bookcase or cabinet, that may impede the flow of air around the appliance.
7. Heat – the appliance should be situated away from heat sources such as radiators, stoves or other appliances that produce heat.
8. Power sources - The appliance is of Class1 construction and shall be connected to a MAINS socket outlet with a protective earthing connection.
9. Power cord protection – power supply cords should be routed so that they are not likely to be walked on or pinched by items placed upon or against them, paying particular attention to cords at plugs, convenience receptacles and the point where they exit the appliance.
10. Cleaning – the appliance should be cleaned only as recommended by the manufacturer.
11. Unattended periods – the power cord of the appliance should be unplugged from the outlet when left unused for a long period of time.
12. Object entry – care should be taken so that objects do not fall into the appliance.
13. Damage requiring service – the appliance should be serviced by qualified service personnel when:
 - i. the power supply cord or the plug has been damaged
 - ii. objects have fallen or liquid has been spilled into the appliance
 - iii. the appliance has been exposed to rain or other serious liquid exposure
 - iv. the appliance does not appear to operate normally or exhibits a marked change in performance
 - v. the appliance has been dropped or the cabinet damaged
14. Servicing – the user should not attempt to service the appliance beyond those measures described in the operating instructions. All other servicing should be referred to qualified service personnel.
15. Grounding or polarisation – precautions should be taken so that grounding or polarisation means for the appliance are not defeated.
16. The Mains disconnection switch is located on the rear panel. Pressing the switch downwards will turn the unit on. The unit can be turned off by upward pressure on the switch. Please allow enough room around the unit to ensure the switch is readily operable when the unit is in use.

Introduction

Welcome. In selecting ATC, you have chosen an example of the finest audio engineering available. ATC was founded on a principle of engineering excellence, and that principle still defines our products today. Given the right opportunities, ATC products will deliver exceptional audio performance, but the opportunities will only arise from careful and thoughtful installation and use. Please read the following manual fully. It will help you understand the product and to realise its full potential. We are happy to answer questions and offer advice on any issues that arise through installation or use of ATC products. Contact details can be found at the back of this manual.

ATC was founded in London in 1974 by Australian emigre Bill Woodman, who still heads the company today. An enthusiastic pianist and engineer, he was naturally drawn to loudspeaker design and after a period working at Goodmans, where many of the names that went on to found British loudspeaker companies began their careers, he struck out on his own. The premise on which ATC began is a simple one, and one that in many respects is still true today: hi-fi loudspeakers tend to be detailed and accurate but of limited dynamic range, while professional monitor speakers tend to express the opposite character. ATC products were designed from the outset to offer the best of both. It's an easy concept to describe, but surprisingly difficult to engineer.

The difficulty inherent in designing such loudspeakers is one of scale. Hi-fi levels of accuracy and detail call for lightweight moving parts and delicate engineering. Professional monitor levels of performance however demand far more robust components engineered to survive the rigours of high level use for extended periods. The only way to combine the two is through precision engineering of a class and scale more often associated with aerospace or motorsport. But the results are worth the effort and the cost. ATC loudspeakers, with their unique in-house designed drivers, combine the best of hi-fi and professional to devastating effect.

ATC has become synonymous with active systems. Choosing to offer active loudspeakers (where the passive crossover network is replaced by active filters and multiple power amplifiers) is simply a result of the uncompromising attitude to loudspeaker design. While passive systems still have their place, and ATC engineering skills can still bring remarkable results from them, "active" is a fundamentally better solution to the problems posed by accurate, high level music reproduction. The ATC instinct is always for the better solution. Not cheaper, not quicker, but better.

It was the development of active loudspeakers that first brought ATC into electronics design and engineering. Active speakers demand multiple power amplifiers, so ATC from the mid-1980s became not just a loudspeaker manufacturing company but an electronics manufacturer too. The further step from electronics for active speakers to a range of stand-alone amplifier products was natural, and now means that ATC engineering is available from the recording desk or CD player output to the ears.

From modest beginnings, ATC has grown to become one of the very few manufacturers successful across both domestic and professional audio. By selecting ATC, you join a group of music lovers, professional audio engineers, studios and musicians across the world that understand and value the engineering that goes into an ATC product - and the sound that comes out.

Contents		
Page 1	Safety Warnings	
Page 2	Introduction	
Page 3	Section 1	Description
	Section 2	Unpacking and Handling
	Section 3	Monitor Placement
	Section 4	Listening
Page 4	SCM20ASL Pro Active Monitors	
	Section 5	Signal Cable Options
Page 5	Section 6	Operation
Page 6	Section 6	Operation
Page 7	SCM20PSL Pro Passive Monitors	
	Section 7	Connection
	Section 8	Amplification
Page 8	Section 9	Specifications
Page 9	Section 10	Care & Maintenance
	Section 11	Warranty & Contact

1. Description

The SCM20 Pro series consists of two models of loudspeaker; one passive, one active. Passive units are denoted by a PSL suffix and active units by an ASL suffix.

Passive monitors are equipped with a "bi-wire" connection panel to enable separate amplification of mid/bass and high frequency drivers if required.

Active units feature a built in two-way amplifier with frequency, gain and phase correction which has been individually optimised at the ATC manufacturing facility. Adjustment of input sensitivity and bass boost is available to the user via controls on the amp rear panel.

2. Unpacking and Handling

Both the SCM20PSL Pro and SCM20ASL Pro are large heavy items and should be handled with care. Always employ a second person to assist in moving them. Unpacking is best carried out on the floor or a large low table, with adequate open space around the carton, preferably close to their final position.

- Open the carton and remove all loose items, leaving the packing foam in place.
- Up-end the carton so the open end is facing down.
- Lift the carton off the contents (speaker & foam 'end-caps').
- Lift the upper foam end cap off.
- Flip the speaker over so it is resting on its base and lift the remaining foam end cap off.
- Remove the tape sealing the plastic bag, open the bag and remove the baffle protector.
- Remove the speaker from the bag and position in the listening/control room.

Fig. 1 Stereo Loudspeaker Positioning

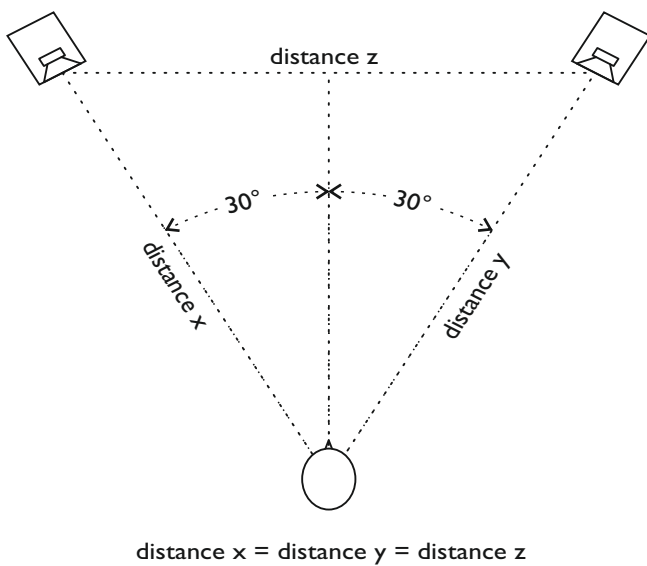

3. Monitor Placement

The subjective performance of any monitor loudspeaker will be influenced by the acoustic character of the room in which it is used and its position within the room. Most often, monitors are installed in rooms which are comfortable to sit and talk in. A mixture of carpets, curtains and soft furnishings will help ensure that the middle and high frequencies are reasonable well controlled. There may, however, be low frequency problems; either too much or too little bass. To minimise low frequency problems:

- Try to position speakers away from walls
- Try to position speakers away from corners
- Try not to position speakers exactly 1/4, 1/3, 1/2, 2/3, 3/4 between parallel walls

In professional installations, try to avoid placing the loudspeakers on the console/desk meter bridge. Typically, this compromises the frequency balance of the loudspeaker, especially in the lower mid range. Mounting the speakers on stands behind the console/desk usually gives better results.

If the balance is bass light the monitors can be moved towards the back walls. If the balance is bass heavy try moving the monitors away from walls/corners. The SCM20ASL Pro features a bass boost/cut control. This should be used for fine tuning rather than to compensate for poor positioning.

For stereo listening, the loudspeakers should be positioned so they form an equilateral triangle with the listening position (see Fig. 1). Loudspeaker stand height should be chosen so the acoustic axis is at ear level (see Fig.2). For most seating positions in professional scenarios, a suitable stand would be 900 - 1000mm or 35.5 - 39.4" tall. Suitable stands should be heavy, rigid and resonance free. If the loudspeakers have to be positioned so the acoustic axis is above ear level, they can be tilted downwards. For loudspeaker positioning for 5.1 or 7.1 surround, please see Fig. 3 on the next page.

All rooms vary, and it is a good idea to experiment with both listening and speaker position until a good compromise is reached. For professional installations the requirements are often very specific. Please consult an experienced acoustician if necessary.

If the monitors are to be placed in any kind of cabinet or enclosure, adequate clearance around the amplifier and a means of cool air entering and hot air exiting the cabinet must be provided. Alternatively, the amplifiers should be removed and installed remotely.

Fig. 2 Acoustic Axis

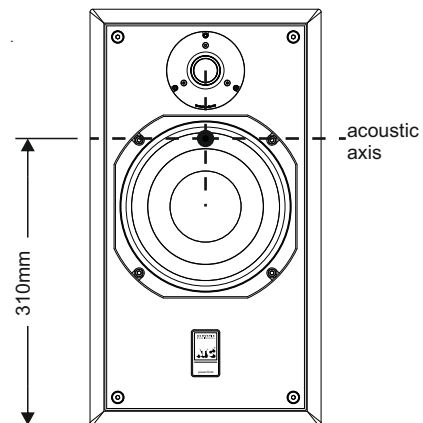

4. Listening

The ear and brain tend to interpret distorted sound as loudness and thus underestimate the actual level of undistorted sound. The SCM20SL Pro (both active and passive), like all ATC monitors, demonstrate very much lower levels of distortion than conventional systems of a similar size. It is therefore advisable to begin listening at an artificially low level and carefully increase the volume. It is also possible for the SCM20SL Pro to produce sufficient sound pressure levels for your ears themselves to become a source of distortion and make the sound appear harsh. Any audible distortion indicates that either the system or your ears are being overloaded and that volumes should be reduced. The user should also bear in mind that the monitoring level in a professional environment can change the way certain sounds are perceived and that for consistent high quality results, consistent and moderate monitoring levels should be used. Look after your ears! You only get the one pair!

Fig. 3. 5.1 and 7.1 Surround Loudspeaker Positioning

- All loudspeakers should be equidistant from the listening position: distance L=C=R=LS=LR=RR=RS
- For 5.1 systems, position the surround speakers between 110° and 150° degrees (ITU spec. is 110°)
- If ideal positioning isn't possible, position loudspeakers as close as possible to ideal.
- Try to avoid placing subwoofers in corners, very close to walls, and on the midpoint between two parallel walls

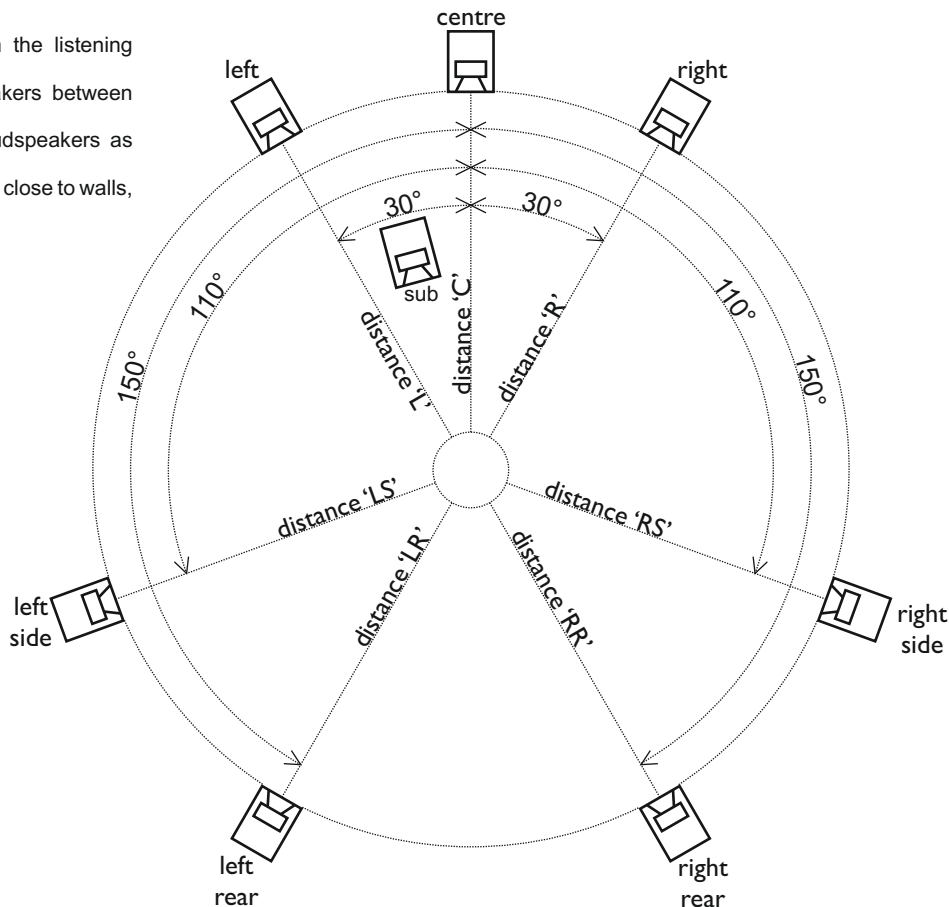

SCM20ASL Pro

5. Signal Cable Options

Balanced cable configuration is the preferred option, however unbalanced connection is possible. Figures 5. & 6. illustrate the signal cable connections required for each option. Balanced (XLR - XLR) connection offers lower noise and better immunity to "hum" pick-up. Unbalanced (XLR - RCA Phono or two-pole jack) connection carries risk of "hum" caused by multiple signal earths. Hum problems resulting from unbalanced connection may be reduced by making ONE of the following modifications to the signal cable:

- If the driving pre-amp or desk is "double insulated" (ie. has no mains earth), disconnect the signal cable screen at the RCA phono plug end.
or
- Disconnect the signal cable screen at the XLR end. This option will make the source the reference signal earth.

Fig. 4. Input connection pins

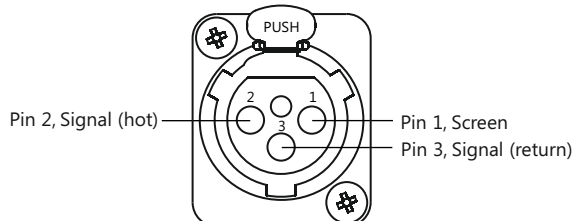

Fig. 5. Balanced cable

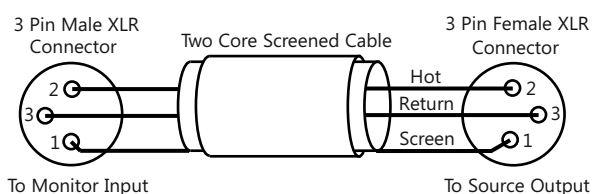
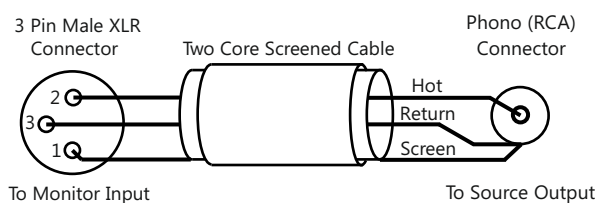

Fig. 6. Unbalanced cable



6. Operation - SCM20ASL Pro

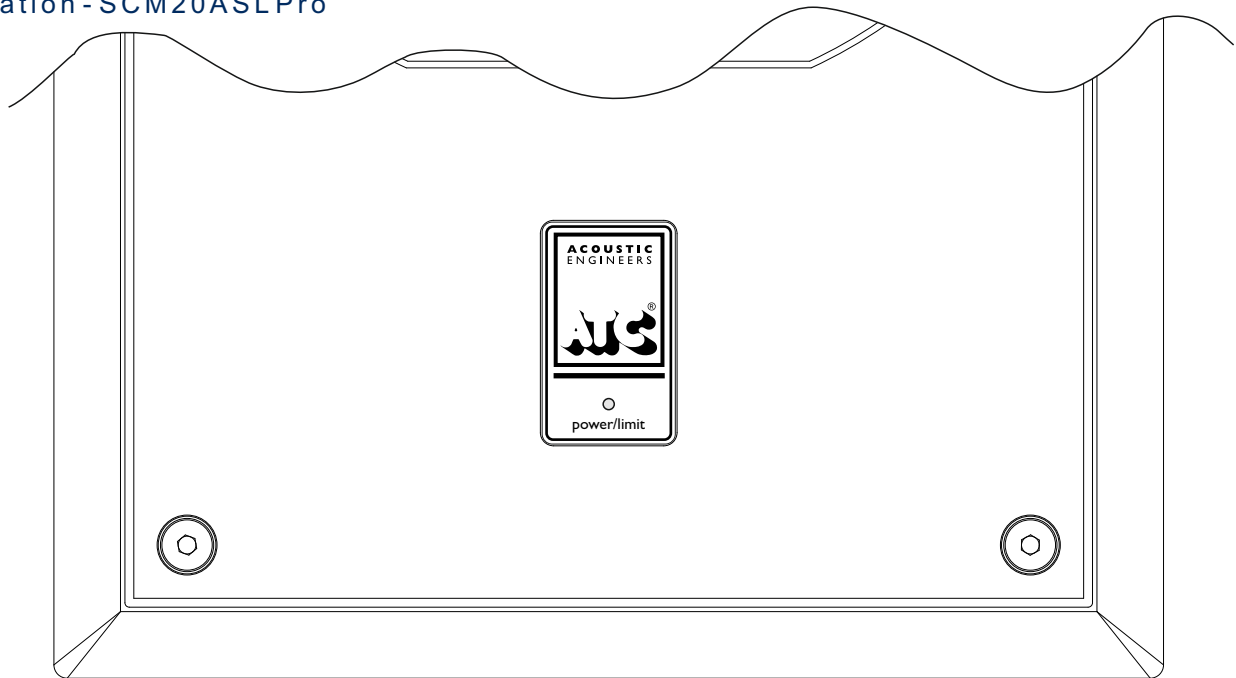

Fig. 7. SCM20ASL Pro Front Baffle

6.1 Power On/Limit LED

Situated on the lower-front baffle of the SCM20ASL Pro is the Power On/Limit indicator LED. When the monitor is powered 'On', the LED will illuminate green. This feature is shown in Fig. 7 above.

When the monitor is driven hard and the amplifier FET limiter begins to act, the LED will turn red. The brighter and longer the duration the LED red 'flash', the more severe the limit event. The FET limiter is designed to stop the amplifier 'hard clipping'. It is not a fail safe way to protect the loudspeaker drive units. When not active, the FET limiter is not in circuit ie. it is a parallel part of the circuitry and it will not reduce sound quality. When the limiter is active it reduces gain with a 'soft clipping' characteristic. Nonetheless, when the limiter is active it does have an affect on the sound quality and the amplifier distortion will increase. At these levels, the loudspeaker drive units will also display much greater non-linearities and the sound pressure level should be reduced if critical judgements made on the monitors are to be trusted.

It should also be noted that the sound pressure levels produced when the amplifier is at full output and the limiter is active are capable of causing hearing damage, especially if the listener is exposed to these levels for sustained periods of time. Critical judgements made on the monitors at full output are also likely to be inaccurate. With ANY studio monitoring system, use consistent and moderate listening levels if consistent and accurate judgements are required.

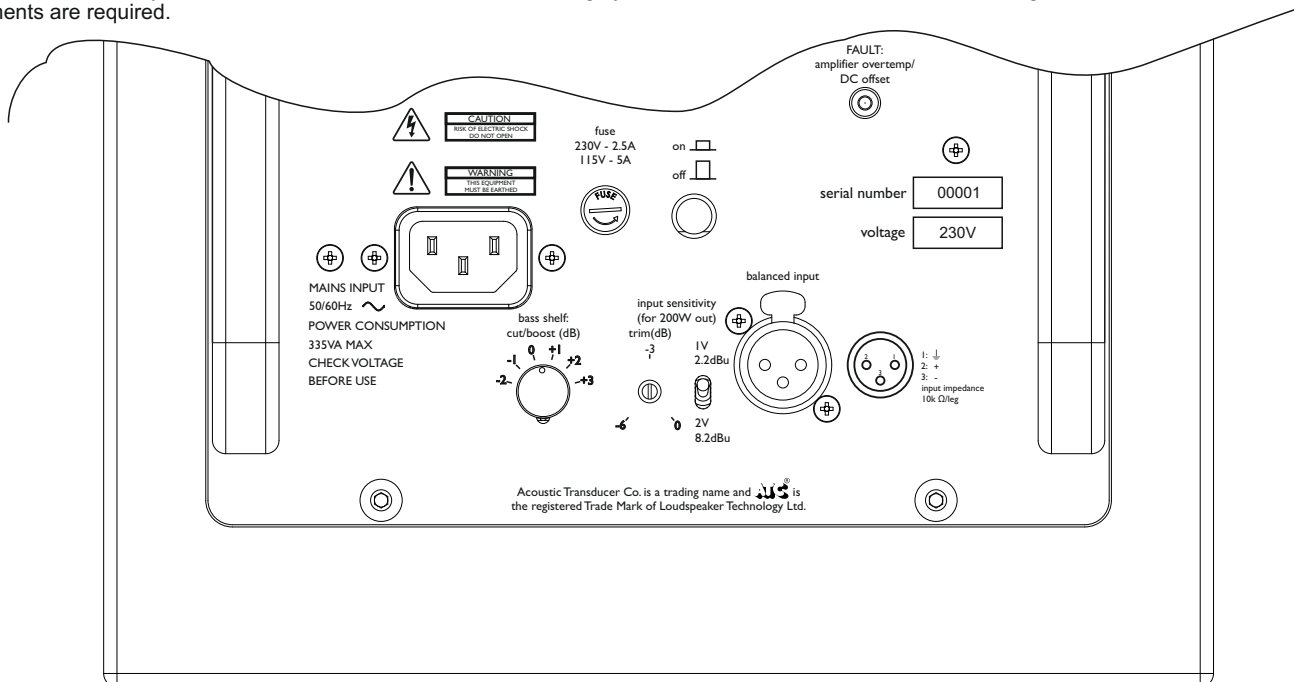

Fig. 8. SCM20ASL Pro Rear Panel

Figure 8. illustrates the connection and control panels for the SCM20ASL Pro amplifier. Each feature is described below.

6.2 Mains Inlet

The supplied mains power lead (appropriate to the local territory) should be connected here. Ensure that the mains voltage specified on the panel corresponds with the local supply voltage.

6.3 Power Switch

Switches on the monitor. When powered up, the front panel power/limit LED will illuminate green.

6.4 Fuseholder

Should a monitor fail to switch on when the power switch is operated, the fuse should be inspected. Lift out the fuseholder cover using a small flat-blade screwdriver, remove the fuse and inspect for damage. If required, a replacement fuse should be fitted. Ratings are printed on the amp rear panel. It should be stressed, however, that fuses most often fail only because of a serious electrical fault. If this is the case then simply replacing the fuse will only result in another fuse failure. The monitor should be returned to ATC or an authorised service technician if a second fuse fails.

6.5 Input Socket

The audio signal cable should be connected here. Balanced or unbalanced cables may be used (see Section 3.).

6.6 Bass Shelf

This adjustment provides -2dB to +3dB of cut and boost, in 1dB steps, in the form of a shelving filter. This subtracts/adds more warmth and energy in the low frequency region. When used to boost it is at the expense of:

- Accurate transient reproduction
- Reduced Headroom
- Increased distortion

Note: This adjustment should be used for fine tuning. Please try to achieve the best possible in-room bass response by first adjusting loudspeaker and listening position and room acoustic treatment if possible.

6.7 Input Sensitivity

This user adjustment is made up of two controls:

a) Selector Switch

This switch toggles between 1V/+2.2dBu and 2V/+8.2dBu input sensitivity (for full amp output). Choose the setting that best suits the source pre-amp, mixer or monitor controller. Input sensitivity can be further fine-tuned using the Input Sensitivity Trim.

Note: For source (driving) equipment with potentiometer based analogue level control, choose an input sensitivity that results in the desired average sound pressure level with the source level control at approximately 50%. For source (driving) equipment with a digital level control, choose an input sensitivity that results in the desired average sound pressure level with the level control at approximately 80%.

b) Trim Pot

This control provides fine adjustment of input sensitivity. Fully clockwise is the factory 'reference' position of 0dB. In this position, the trim has no effect on the input sensitivity which is controlled by the switch described above. Turning the control anti-clockwise will result in up to -6dB of adjustment. The combination of the two controls gives a total input sensitivity range of 1V/+2.2dBu to 4V/+14.2dBu (for full amplifier output of 200W).

6.8 Fault LED

This LED will illuminate if one of two fault conditions occurs within the amplifier:

- 1) Thermal Overload - amplifier plate temperature > 60°C
- 2) Output DC offset - amplifier output DC offset > 100mV

If thermal overload is suspected - an amp plate of 60°C is uncomfortable to touch - turn off the amp and leave it to cool for 15 minutes. If the amplifier re-starts without the fault LED, the temperature will have fallen and the fault cleared.

However, thermal overload is not typical. The heat sinking on the amplifier has been specified to control the amp temperature under normal working conditions. If the amplifier plate has reached 60°C, then it is very likely one of the following conditions applies:

- 1) The monitor is being driven continuously at very high SPL or with signals that are continuous in nature ie. sine waves - **REDUCE THE SOUND PRESSURE LEVEL**
- 2) The heat sink and amp plate are covered or partially covered, blocking or reducing the cooling airflow - **DO NOT RESTRICT COOLING**
- 3) Ambient temperature in the control/listening room or in the area in close proximity to the monitor is in excess of 33°C - **REDUCE AMBIENT TEMPERATURE**

Failure to correct any of the above is likely to result in excessive amp heating and repeated thermal trips.

Condition 1. is likely to cause premature drive unit failure and accelerated amplifier component ageing.

Conditions 2. & 3. are likely to cause accelerated amplifier component ageing.

If the amplifier will not re-start after a cooling period, it is highly likely there is a fault leading to a DC voltage in excess of 4.0V on the amplifier outputs. This will require repair by ATC or a approved service engineer. Please contact your local ATC dealer or ATC direct if this is the case.

Note:

Due to the nature of the electronics in ATC active loudspeakers it is quite normal for a sound to be heard from the speaker when the power is applied or disconnected. The noise heard, and the movement observed in the bass drive unit will not damage the speaker, and is quite normal. Although ATC uses the highest-grade components, a different noise may be heard from each speaker due to slight tolerance variations in the amplifier components.

SCM20PSL Pro

7. Connection

The SCM20PSL Pro monitors are equipped with a “bi-wire” connection panel to enable separate amplification of the bass/mid driver and tweeter. The connection panel is shown in Fig. 8 below. If not bi-wiring, connect your speaker cable to either the upper or lower horizontal pair of terminals. Remove the linking bars, between vertical pairs of terminals should you wish to take advantage of the bi-wire facility. The upper horizontal pair of terminals are connected to the tweeter. The lower horizontal pair are connected to the bass driver.

Terminals can accommodate either stripped bare cable ends, 4mm banana plugs or spade terminals. Do not use crimps on the bare wire ends as the difficulty in compressing them can cause poor link bar connection. Always use a good quality speaker cable with 2.5mm² minimum cross sectional area per conductor (79 strand). For cable runs longer than 5m use a significantly heavier gauge cable. Consult your dealer or consultant for specific cable recommendations. Ensure that the positive and negative terminals on each connection panel are connected to the corresponding positive and negative terminals on the amplifier.

A lack of bass output and very wide unstable stereo image is most likely caused by the left and right loudspeakers being connected out of phase. If the system displays these characteristics, please check the polarity of the wiring.

Fig. 8. SCM20PSL Pro Passive Input Panel

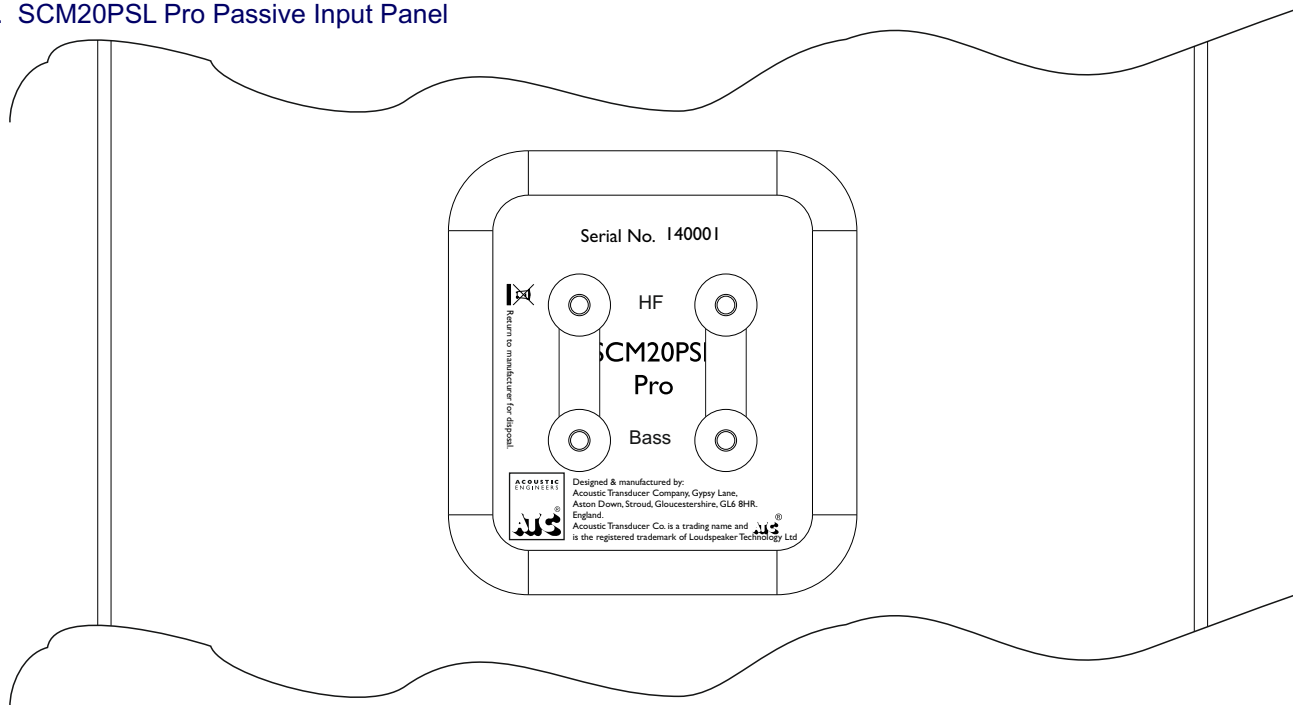

8. Amplification

The choice of partnering amplifier to power the SCM20PSL Pro monitors will have significant influence on the performance of the system. Consider the following when selecting an amplifier:

- With any passive loudspeaker there is a trade off between low frequency extension and sensitivity. These monitor's extended low frequency response means the sensitivity is relatively low. It is therefore advisable to select a power amplifier of relatively high power output capabilities. Typically, best performance comes with use of amplifiers capable of >150W continuous into 8 ohms.
- Use of an underpowered amplifier will result in the premature distortion of the system and increased risk of damage due to voice coil overheating
- Valve or solid state amplifiers with high output impedances should be auditioned carefully, to establish that their characteristic reduced damping factor at low frequencies is acceptable.
- Thanks in part to Super Linear technology and the underhung voice coil construction, these monitors not only demonstrate extremely low distortion at all levels, but also a greatly enhanced effective dynamic range. This exceptional distortion performance, combined with a very wide dispersion will ruthlessly reveal deficiencies in ancillary equipment. It is advisable, therefore, to audition the monitors with your proposed amplifier and ancillary system.

9. Specifications

SCM20ASL Pro

1. Acoustic

- Drive unit - Low Frequency (LF) 6.5"/150mm Super Linear with 75mm/3" voice coil (SB75-150SL 8 Ohm)
- Drive unit - High Frequency (HF) 1"/25mm dual suspension Soft Dome (SH25-76S 6 Ohm)

- Amplitude linearity 80Hz - 20kHz (+/-2dB)
- Cut-off frequencies 55Hz - 25kHz (-6dB freestanding)
- Horizontal dispersion +/-80° coherent
- Vertical dispersion +/-10° coherent
- Maximum continuous SPL 108dB (per pair @ 1m)
- Crossover frequency 2.1kHz

2. Electronic

- Audio input Rear panel mounted female XLR (pin 2 +ve)
- Input sensitivity 1V/2V RMS or +2.2/+8.2dBu via switch (ref. bass full output)
- Input sensitivity trim 0dB to -6dB (via rear panel pot)
- Total input sensitivity range 1V/+2.2dBu to 4V/+14.2dBu
- Input impedance 10kΩ per leg
- LF amp max output power 200W continuous (1% THD)
- HF amp max output power 50W continuous (1% THD)
- THD LF amp 0.0006%/-104.4dB (100Hz, 1dB below rated power)
- THD HF amp 0.0022%/-93.2dB (10kHz, 1dB below rated power)
- Crossover filters 2nd order/ 12dB/oct critically damped with phase compensation
- HF upper -3dB point 250kHz
- S+N/N ratio - LF 112dBA (Max. gain, ref. 40V out, IEC 'A')
- S+N/N ratio - HF 109dBA (Max. gain, ref. 20V out, IEC 'A')
- Low frequency shelf cut/boost 80Hz, -2dB to +3dB in 1dB steps (via rear panel rotary switch)
- Overload protection Active FET momentary gain reduction (inc. front panel mounted 'limit' LED)
Amplifier thermal trip circuit
- Mains power requirements 115/230V, 50/60Hz (internally selectable by technician). 100V 50/60Hz factory set.
- Max power consumption 381Watts/483VA
- Accessories K&M 24120 Wall Mount (cabinet requires modification to accept 'top-hat' mount)
- Weight 28kg/61.6lbs (per cabinet)

SCM20PSL Pro

- Drive unit - Low Frequency (LF) 6.5"/150mm Super Linear with 75mm/3" voice coil (SB75-150SL 8 Ohm)
- Drive unit - High Frequency (HF) 1"/25mm dual suspension Soft Dome (SH25-76S 6 Ohm)

- Amplitude linearity 80Hz - 20kHz (+/-2dB)
- Cut-off frequencies 55Hz - 25kHz (-6dB freestanding)
- Horizontal dispersion +/-80° coherent
- Vertical dispersion +/-10° coherent
- Maximum continuous SPL 108dB (per pair @ 1m)
- Crossover frequency 2.1kHz

- Recommended Power Amplifier 75 to 300 Watts
- Nominal Impedance 8 Ohm
- Connectors 2 x Pairs Binding Posts/4mm Plugs - Bi-Wireable

- Accessories K&M 24120 Wall Mount (cabinet requires modification to accept 'top-hat' mount)

- Cabinet Dimensions (HxWxD) 450x250x294mm
- Weight 18kg/39.7lbs (per cabinet)

10. Care and Maintenance

High technology material finishes are used in this product. The surfaces are durable and with a little care can be kept as good as new, even under conditions of heavy use. Normally a dry duster will be all that is required to keep the finishes clean.

Heavy soiling can be cleaned using a cloth slightly moistened with a non-abrasive household cleaner.

There are no components within the speaker that can be considered expendable, or that would benefit from regular maintenance. There is no requirement for any kind of routine service work and there is no schedule for preventative maintenance.

There are no user replaceable parts within the speaker and in the unfortunate event of any malfunction, repair should be referred to either the supplying dealer or consultant, the relevant importer, or ATC. ATC has every confidence in the quality of each product that it manufactures.

11. Warranty and Contact

All ATC products are guaranteed against any defect in materials or workmanship for a period of two years from the date of purchase. Within this period we will supply replacement parts free of charge provided that the failure was not caused by misuse, accident or negligence.

Purchasers who complete and return the Warranty Card will have their warranty period extended up to a period of six years from the date of purchase. This guarantee does not limit statutory rights.

ATC can be contacted at:

Loudspeaker Technology Ltd, Gypsy Lane, Aston Down, Stroud, Gloucestershire, GL6 8HR

Telephone: 01285 760561

Fax: 01285 760683

Email: info@atc.gb.net

Website: www.atcloudspeakers.gb.net



Loudspeaker Technology Ltd Gypsy Lane, Aston Down, Stroud, Gloucestershire GL6 8HR United Kingdom

Telephone 01285 760561 Fax 01285 760683

Email: info@atc.gb.net Web: www.atcloudspeakers.co.uk